

F O R T Y F I V E _ N I N E T Y

I N D I C E

I N D E X

	Scrivanie prof. 90. 161
	Desks, depth 90
	Scrivanie prof. 65. 162
	Desks, depth 65
	Allunghi 164
	Prolongations
	Tavoli riunione. 165
	Meeting tables
	Tavoli Caffè - Tavoli circolari. 169
	Coffee tables - Circular tables
	Cassettiere 171
	Pedestals
	Contenitori di servizio. 172
	Service units
	Contenitori h. 84,5 173
	Storage units, h. 84,5
	Contenitori h. 161,2 179
	Storage units, h. 161,2
MODIFICHE PRODUTTIVE	Contenitore pensile 185
La ditta si riserva di apportare	Hanging storage units
modifiche dimensionali o	Mini cool e Serrature 186
strutturali ai suoi prodotti in	Mini cool and Locks
qualsiasi momento e senza	Sottomano e Vertebra passacavi. 186
alcun preavviso.	Whriting pad and Writing vertebra
PRODUCTION MODIFICATIONS	Accessori per contenitori. 187
The company reserves the	Storage units accessories
right to modify the structure	
or dimensions of its products	
without notice at any time.	

SCRIVANI E TAVOLI RIUNIONE

Piani per scrivanie, tavoli riunione ed allunghi realizzati con pannelli in fibra di legno sp.15 mm placcati a caldo con impiallacciatura di Ebano in abbinamento con profilo alluminio "brill" o Palissandro in abbinamento con profilo alluminio "bianco", bordi in legno sp.1mm.

Verniciatura naturale effettuata con vernici acriliche antingiallenti.

I piani in cristallo, sono realizzati con vetro temperato verniciato bianco extrachiaro o nero, sp. 10 mm angoli filo lucido.

I piani in cuoio (sp. 2 mm), sono realizzati con pannelli in MDF placcati con cuoio bianco o testa di moro e cuciture color corda.

Piedini livellatori previsti di serie.

Le gambe, i telai e le travi che compongono la struttura delle scrivanie e dei tavoli riunione, sono realizzati in alluminio in due finiture, ossidato brillante o verniciato bianco.

ELETTRIFICAZIONE

Tutti gli elementi utilizzati per l'elettrificazione della scrivania, passacavi vaschette e top access, sono realizzati in alluminio ossidato o verniciato bianco.

GONNE

Le gonne sono realizzate con impiallacciatura di Ebano, Palissandro o cuoio, bordi in legno sp.1 mm

DESKS AND MEETING TABLES

Desktops, meeting tables and extensions made of 15 mm thick wood fibreboard panels, hot surfaced with ebony veneer teamed with "brill" aluminium profile or Rosewood veneer teamed with "white" aluminium profile, 1 mm thick wooden borders.

Coated with anti-yellowing acrylic varnishes.

The glass tops are made of tempered glass, painted white extraclear or black, 10 mm thick with polished flush edges.

The leather tops (2 mm thick) are made of MDF panels surfaced with white or brown leather and rope coloured seams.

Adjustable feet supplied as standard.

The legs, frames and beams that make up the structure of the desks and meeting tables are made of aluminium in two finishes, brilliant oxidised or painted white.

CABLE MANAGEMENT

All the components of the desk cable management, tray ducting and top access are made of oxidised aluminium or painted white.

MODESTY PANELS

The modesty panels are made with ebony or rosewood veneer or leather, with 1 mm thick wooden borders.

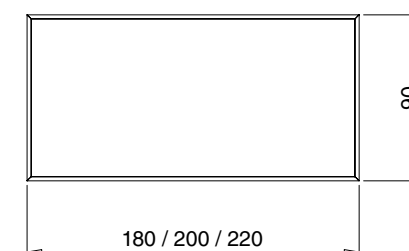
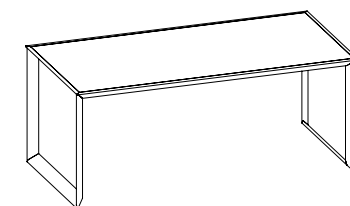

P. KG WEIGHT	VOL. M3 VOLUME	LARG. CM WIDTH	PROF. CM DEPTH	ALT. CM HEIGHT	COD. CODE	FINITURE PIANO TOP FINISHES	FINITURE SOSTEGNO SUPPORT FINISHES
-----------------	-------------------	-------------------	-------------------	-------------------	--------------	--------------------------------	---------------------------------------

Scrivania Desk 180 x 90

39,9	0,168	180	90	74	9RAL01.0001.51	palissandro rosewood	(58) brill brill	(59) bianco white
					9RAL01.0001.52	ebano ebony		
					9RAL01.0001.56	cuoio bianco white leather		
					9RAL01.0001.57	cuoio moro brown leather		

Scrivania Desk 200 x 90

65,0	0,254	180	90	74	9RAL81.0030.54	vetro bianco white glass		
					9RAL81.0030.55	vetro nero black glass		

Scrivania Desk 200 x 90

42,8	0,179	200	90	74	9RAL02.0001.51	palissandro rosewood		
					9RAL02.0001.52	ebano ebony		
					9RAL02.0001.56	cuoio bianco white leather		
					9RAL02.0001.57	cuoio moro brown leather		

Scrivania Desk 220 x 90

70,8	0,274	200	90	74	9RAL82.0030.54	vetro bianco white glass		
					9RAL82.0030.55	vetro nero black glass		

Scrivania Desk 220 x 90

45,8	0,189	220	90	74	9RAL03.0001.51	palissandro rosewood		
					9RAL03.0001.52	ebano ebony		
					9RAL03.0001.56	cuoio bianco white leather		
					9RAL03.0001.57	cuoio moro brown leather		

Scrivania Desk 220 x 90

76,6	0,294	220	90	74	9RAL83.0030.54	vetro bianco white glass		
					9RAL83.0030.55	vetro nero black glass		

Elettrificazione per scrivania, (top access, vaschetta sottopiano e carter)
Cable management (top access cable tray and carter)

9RAQ01.0008	per piano in legno e cuoio for leather and veneered top
9RAQ01.0030	per piano in vetro for glass top



SCRIVANIA P. 65 DESK D.65

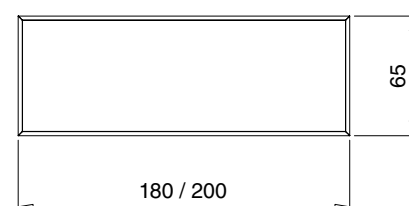
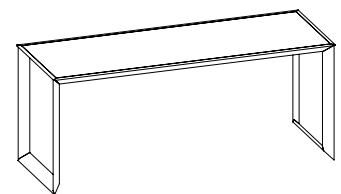

P. KG WEIGHT	VOL. M3 VOLUME	LARG. CM WIDTH	PROF. CM DEPTH	ALT. CM HEIGHT	COD. CODE	FINITURE PIANO TOP FINISHES	FINITURE SOSTEGNO SUPPORT FINISHES
Scrivania Desk 180 x 65							
32,9	0,121	180	65	74	9RAL11.0001.51	palissandro rosewood	(58) brill brill
					9RAL11.0001.52	ebano ebony	(59) bianco white
					9RAL11.0001.56	cuoio bianco white leather	
					9RAL11.0001.57	cuoio moro brown leather	
50,6	0,184	180	65	74	9RAL91.0030.54	vetro bianco white glass	
					9RAL91.0030.55	vetro nero black glass	
Scrivania Desk 200 x 65							
35,3	0,129	200	65	74	9RAL12.0001.51	palissandro rosewood	
					9RAL12.0001.52	ebano ebony	
					9RAL12.0001.56	cuoio bianco white leather	
					9RAL12.0001.57	cuoio moro brown leather	
55,1	0,199	200	65	74	9RAL92.0030.54	vetro bianco white glass	
					9RAL92.0030.55	vetro nero black glass	

Elektrificazione per scrivania, (top access, vaschetta sottopiano e carter)
Cable management (top access cable tray and carter)

- 9RAQ01.0008** per piano in legno e cuoio
for leather and veneered top
- 9RAQ01.0030** per piano in vetro for glass top



GONNE MODESTY PANELS

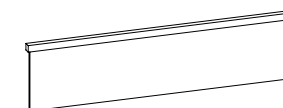

P. KG WEIGHT	VOL. M3 VOLUME	LARG. CM WIDTH	PROF. CM DEPTH	ALT. CM HEIGHT	COD. CODE	FINITURE PIANO TOP FINISHES	FINITURE SOSTEGNO SUPPORT FINISHES
Gonna per scrivanie L. 180 Modesty panel for desk 180 l.							
9,5	0,026	159	2	36,5	9RAQ01.0001	palissandro rosewood	(58) brill brill
					9RAQ01.0002	ebano ebony	(59) bianco white
					9RAQ01.0003	cuoio bianco white leather	
					9RAQ01.0004	cuoio moro brown leather	
Gonna per scrivanie L. 200 Modesty panel for desk 200 l.							
9,5	0,026	179	2	36,5	9RAQ02.0001	palissandro rosewood	
					9RAQ02.0002	ebano ebony	
					9RAQ02.0003	cuoio bianco white leather	
					9RAQ02.0004	cuoio moro brown leather	
Gonna per scrivanie L. 220 Modesty panel for desk 220 l.							
9,5	0,026	199	2	36,5	9RAQ03.0001	palissandro rosewood	
					9RAQ03.0002	ebano ebony	
					9RAQ03.0003	cuoio bianco white leather	
					9RAQ03.0004	cuoio moro brown leather	

ALLUNGO PROLONGATION

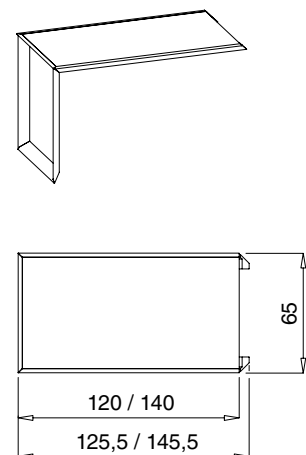

P. KG WEIGHT	VOL. M3 VOLUME	LARG. CM WIDTH	PROF. CM DEPTH	ALT. CM HEIGHT	COD. CODE	FINITURE PIANO TOP FINISHES	FINITURE SOSTEGNO SUPPORT FINISHES
Allungo Prolongation 120 x 65							
20,3	0,074	120	65	74	9RAL14.0001.51	palissandro rosewood	(58) brill brill
					9RAL14.0001.52	ebano ebony	(59) bianco white
					9RAL14.0001.56	cuoio bianco white leather	
					9RAL14.0001.57	cuoio moro brown leather	
32,3	0,117	120	65	74	9RAL95.0030.54	vetro bianco white glass	
					9RAL95.0030.55	vetro nero black glass	
Allungo Prolongation 140 x 65							
22,8	0,082	140	65	74	9RAL15.0001.51	palissandro rosewood	
					9RAL15.0001.52	ebano ebony	
					9RAL15.0001.56	cuoio bianco white leather	
					9RAL15.0001.57	cuoio moro brown leather	
36,7	0,132	140	65	74	9RAL96.0030.54	vetro bianco white glass	
					9RAL96.0030.55	vetro nero black glass	



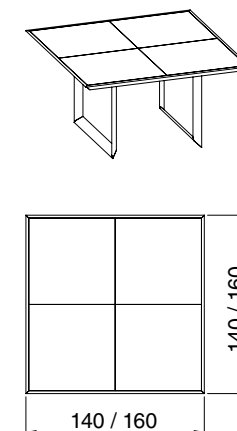

TAVOLO RIUNIONI MEETING TABLE





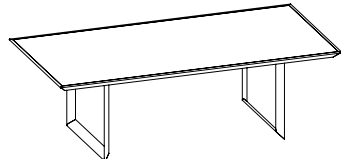
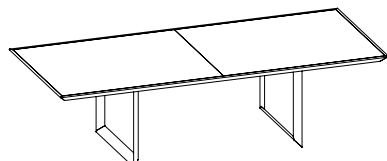
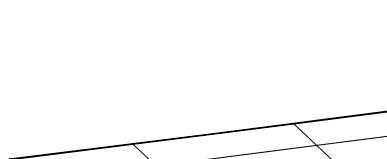
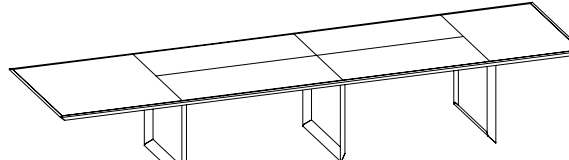
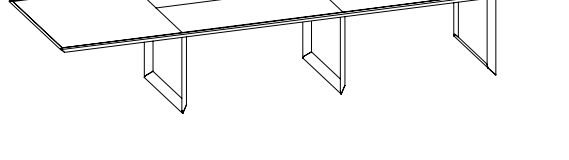

P. KG WEIGHT	VOL. M3 VOLUME	LARG. CM WIDTH	PROF. CM DEPTH	ALT. CM HEIGHT	COD. CODE	FINITURE PIANO TOP FINISHES	FINITURE SOSTEGNO SUPPORT FINISHES
Tavolo riunione Meeting table 140x140							
55,6	0,185	140	140	74	9RAL71.0001.51	palissandro rosewood	(58) brill brill
					9RAL71.0001.52	ebano ebony	(59) bianco white
					9RAL71.0001.56	cuoio bianco white leather	
					9RAL71.0001.57	cuoio moro brown leather	
Tavolo riunione Meeting table 160x160							
66,0	0,221	160	160	74	9RAL75.0001.51	palissandro rosewood	
					9RAL75.0001.52	ebano ebony	
					9RAL75.0001.56	cuoio bianco white leather	
					9RAL75.0001.57	cuoio moro brown leather	
Tavolo riunione in vetro Glass top meeting table 140x140							
86,3	0,288	140	140	74	9RAL71.0030.54	vetro bianco white glass	(58) brill brill
					9RAL71.0030.55	vetro nero black glass	(59) bianco white
Tavolo riunione in vetro Glass top meeting table 160x160							
106,4	0,355	160	160	74	9RAL75.0030.54	vetro bianco white glass	
					9RAL75.0030.55	vetro nero black glass	

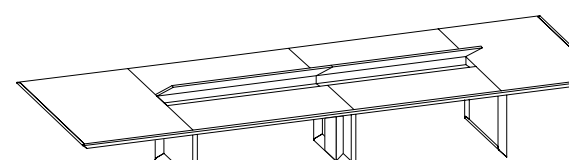
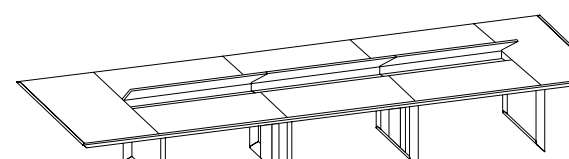

Elettrificazione per tavolo riunioni (passacavo, vaschetta sottopiano e carter)
Cable management (Top access, cable tray and carter)

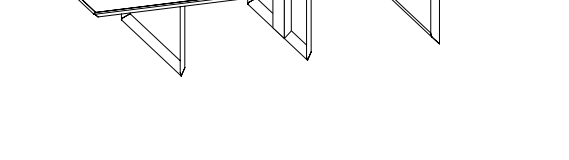
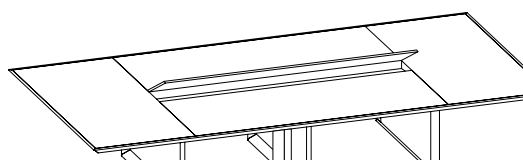
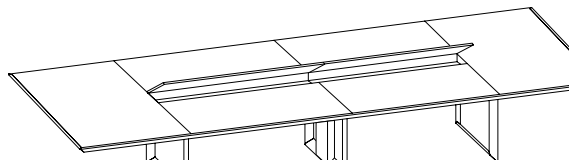
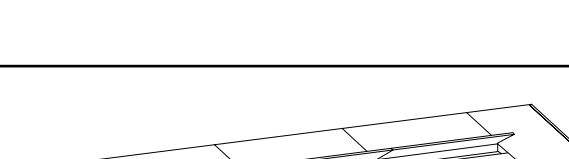
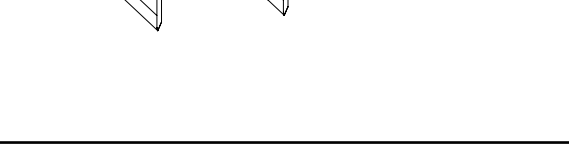
9RAQ04.0008	per piano in legno e cuoio for leather and veneered top
9RAQ04.0030	per piano in vetro for glass top

FORTYFIVE_NINETY		TAVOLO RIUNIONI P. 120 MEETING TABLE D. 120									
		P. KG WEIGHT	VOL. M3 VOLUME	LARG. CM WIDTH	PROF. CM DEPTH	ALT. CM HEIGHT	COD. CODE	FINITURE PIANO TOP FINISHES	FINITURE SOSTEGNO SUPPORT FINISHES		
	Tavolo riunioni Meeting table 240 x 120										
	95	0,240	240	120	74	9RAL73.0001.51	palissandro rosewood	(58) brill brill	(59) bianco white		
						9RAL73.0001.52	ebano ebony				
						9RAL73.0001.56	cuoio bianco white leather				
	Tavolo riunioni Meeting table 320 x 120										
	137	0,390	240	120	74	9RAL73.0030.54	vetro bianco white glass				
						9RAL73.0030.55	vetro nero black glass				
						9RAL77.0001.51	palissandro rosewood				
	Tavolo riunioni Meeting table 320 x 120										
	110	0,310	320	120	74	9RAL77.0001.52	ebano ebony				
						9RAL77.0001.56	cuoio bianco white leather				
						9RAL77.0001.57	cuoio moro brown leather				
	Tavolo riunioni Meeting table 400 x 120										
	168	0,460	320	120	74	9RAL77.0030.54	vetro bianco white glass				
						9RAL77.0030.55	vetro nero black glass				
						9RAL78.0001.51	palissandro rosewood				
	Tavolo riunioni Meeting table 400 x 120										
	140	0,310	400	120	74	9RAL78.0001.52	ebano ebony				
						9RAL78.0001.56	cuoio bianco white leather				
						9RAL78.0001.57	cuoio moro brown leather				
	Tavolo riunioni Meeting table 400 x 120										
	210	0,460	400	120	74	9RAL78.0030.54	vetro bianco white glass				
						9RAL78.0030.55	vetro nero black glass				
	Elettrificazione per tavolo riunione (passacavo, vaschette sottopiano e carter) Cable management (top access, cable trays and carter)							9RAQ03.0008	per piano in legno e cuoio for worktop in veneer and leather		
							9RAQ03.0030	per piano in vetro for glass top			
* Specificare nell'ordine la posizione del passacavo - Specify the position of the top access when ordering											
FORTYFIVE_NINETY		OPTIONAL									
	Sistema Axial 3 composto da 1 presa Italia + 1 presa Schuko + 1 Dati RJ45 Cat. 5 schermata. Cavo alimentazione rete elettrica Mt. 4 con presa Schuko. Axial 3 system composed of 1 Italian socket + 1 Schuko socket + 1 Datas RJ45 Cat. 5 screen. Electric cable for feeding mt. 4 with Schuko socket.										
	9VHAZX5400										
	Sistema Turn 3 composto da 1 presa Italia + 1 presa Schuko + 1 Dati RJ45 Cat. 5 schermata. Cavo alimentazione rete elettrica Mt. 4 con presa Schuko. Turn 3 system composed of 1 Italian socket + 1 Schuko socket + 1 Datas RJ45 Cat. 5 screen. Electric cable for feeding mt. 4 with Schuko socket.										
	9VHAZJ040										
Su richiesta disponibili nelle versioni internazionali. Available upon request in the international versions.											

FORTYFIVE_NINETY		TAVOLO RIUNIONI P. 160 MEETING TABLE D. 160									
		P. KG WEIGHT	VOL. M3 VOLUME	LARG. CM WIDTH	PROF. CM DEPTH	ALT. CM HEIGHT	COD. CODE	FINITURE PIANO TOP FINISHES	FINITURE SOSTEGNO SUPPORT FINISHES		
	Tavolo riunioni Meeting table 480 x 160										
	190	0,240	480	160	74	9RAL79.0001.51	palissandro rosewood	(58) brill brill	(59) bianco white		
						9RAL79.0001.52	ebano ebony				
						9RAL79.0001.56	cuoio bianco white leather				
	Tavolo riunioni Meeting table 480 x 160										
	310	0,390	480	160	74	9RAL79.0030.54	vetro bianco white glass				
						9RAL79.0030.55	vetro nero black glass				
						9RAL80.0001.51	palissandro rosewood				
	Tavolo riunioni Meeting table 560 x 160										
	220	0,310	560	160	74	9RAL80.0001.52	ebano ebony				
						9RAL80.0001.56	cuoio bianco white leather				
						9RAL80.0001.57	cuoio moro brown leather				
	Tavolo riunioni Meeting table 560 x 160										
	350	0,460	560	160	74	9RAL80.0030.54	vetro bianco white glass				
						9RAL80.0030.55	vetro nero black glass				
	Elettrificazione per tavolo riunione (passacavo, vaschette sottopiano e carter) Cable management (top access, cable trays and carter)							9RAQ03.0008	per piano in legno e cuoio for worktop in veneer and leather		
							9RAQ03.0030	per piano in vetro for glass top			
* Specificare nell'ordine la posizione del passacavo - Specify the position of the top access when ordering											
FORTYFIVE_NINETY		TAVOLO RIUNIONI P. 200 MEETING TABLE D. 200									
	Tavoli riunioni Meeting table 400 x 200										
	196,0	0,625	400	200	74	9RAL68.0001.51	palissandro rosewood	(58) brill brill	(59) bianco white		
						9RAL68.0001.52	ebano ebony				
						9RAL68.0001.56	cuoio bianco white leather				
	Tavoli riunioni Meeting table 400 x 200										
	322,3	1,026	400	200	74	9RAL68.0030.54	vetro bianco white glass				
						9RAL68.0030.55	vetro nero black glass				
						9RAL69.0001.51	palissandro rosewood				
	Tavolo riunioni Meeting table 480 x 200										
	270	0,625	480	200	74	9RAL69.0001.52	ebano ebony				
						9RAL69.0001.56	cuoio bianco white leather				
						9RAL69.0001.57	cuoio moro brown leather				
	Tavoli riunioni Meeting table 480 x 200										
	416	1,026	480	200	74	9RAL69.0030.54	vetro bianco white glass				
						9RAL69.0030.55	vetro nero black glass				
						9RAL70.0001.51	palissandro rosewood				
	Tavoli riunioni Meeting table 560 x 200										
	340	0,625	560	200	74	9RAL70.0001.52	ebano ebony				
						9RAL70.0001.56	cuoio bianco white leather				
						9RAL70.0001.57	cuoio moro brown leather				
	Tavoli riunioni Meeting table 560 x 200										
	510	1,026	560	200	74	9RAL70.0030.54	vetro bianco white glass				
						9RAL70.0030.55	vetro nero black glass				
	Pannello centrale apribile per elettrificazione Central panel openable for cable management							Su richiesta tavoli con misure speciali On request tables with special measures			

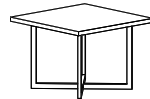
FORTYFIVE_NINETY	DESCRIZIONE TECNICA TECHNICAL DESCRIPTION
	<p>TAVOLI CAFFE' Tavoli caffè 60*60*45: Piano realizzato con pannelli in fibra di legno sp.15 mm placcati a caldo con impiallacciatura di Ebano o Palissandro, bordi in legno sp.1 mm. Il piano in cuoio (sp.2 mm), è realizzato con pannelli in mdf placcati con cuoio bianco o testa di moro e cuciture color corda. Il piano in vetro verniciato temperato filo lucido sp.12 mm . finitura Bianco extrachiaro o Nero. Sostegno in tubolare di acciaio 30x20 mm cromato o verniciato Bianco.</p> <p>Tavolo caffè 120*60*45: Piano realizzato con pannelli in fibra di legno sp.15 mm placcati a caldo con impiallacciatura di Ebano in abbinamento con profilo alluminio "brill" o Palissandro in abbinamento con profilo alluminio "bianco", bordi in legno spessore 1mm. Il piano in cuoio (sp.2 mm), è realizzato con pannelli in MDF placcati con cuoio bianco o testa di moro e cuciture color corda. Il piano in vetro verniciato temperato filo lucido sp.12 mm finitura Bianco extra chiaro o Nero. Le gambe sono realizzati in alluminio in due finiture, ossidato brillante o verniciato bianco.</p> <p>TAVOLO RIUNIONE CIRCOLARE Ø 120 Piani: Piano realizzato con pannelli in fibra di legno sp.15 mm, placcati a caldo con impiallacciatura di Ebano o Palissandro, bordi in legno spessore 1mm. Il piano in vetro verniciato temperato filo lucido sp.12 mm . finitura Bianco extrachiaro o Nero. Sostegni in acciaio pressopiegato finitura brill o verniciato bianco.</p> <p>COFFEE TABLES Coffee table 60*60*45: Desktop made of 15 mm thick wood fibreboard panels, hot surfaced with ebony veneer or Rosewood veneer, 1 mm thick wooden borders. The leather top (2 mm thick) is made of MDF panels surfaced with white or brown leather and rope coloured seams. The glass top made of tempered glass, painted white extraclear or black, 12 mm thick with polished flush edges. Support tubular steel 30x20 mm chromed or painted white.</p> <p>Coffee table 120*60*45 Desktop made of 15 mm thick wood fibreboard panels, hot surfaced with ebony veneer teamed with "brill" aluminium profile or Rosewood veneer teamed with "white" aluminium profile, 1 mm thick wooden borders. The leather tops (2 mm thick) is made of MDF panels surfaced with white or brown leather and rope coloured seams. The glass tops made of tempered glass, painted white extra clear or black , 12 mm thick with polished flush edges. The legs, frames and beams that are made of aluminium in two finishes, brilliant oxidised or painted white.</p> <p>CIRCULAR MEETING TABLES Ø 120 Tops: Desktop made of 15 mm thick wood fibreboard panels, hot surfaced with ebony veneer or Rosewood veneer, 1 mm thick wooden borders. The glass tops made of tempered glass, painted white extra clear or black , 12 mm thick with polished flush edges. Supports thick pressure bent sheet steel, in brill or painted white.</p>

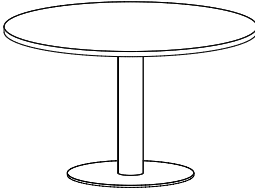
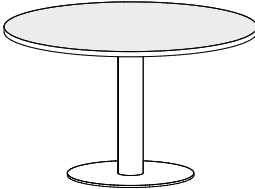
FORTYFIVE_NINETY	TAVOLO CAFFE' COFFEE TABLES									
 	P. KG WEIGHT	VOL. M3 VOLUME	LARG. CM WIDTH	PROF. CM DEPTH	ALT. CM HEIGHT	COD. CODE	FINITURE PIANO TOP FINISHES	FINITURE SOSTEGNO SUPPORT FINISHES	(58) brill brill	(59) bianco white
	Tavolo caffè Coffee table	15	0,150	60	60	45	9RAL52.0001.51	palissandro rosewood		
						9RAL52.0001.52	ebano ebony			
						9RAL52.0001.56	cuoio bianco white leather			
						9RAL52.0001.57	cuoio moro brown leather			
	20	0,200	60	60	45	9RAL52.0030.54	vetro bianco white glass			
						9RAL52.0030.55	vetro nero black glass			
Tavolo caffè Coffee table	35	0,100	120	60	45	9RAL50.0001.51	palissandro rosewood			
						9RAL50.0001.52	ebano ebony			
						9RAL50.0001.56	cuoio bianco white leather			
						9RAL50.0001.57	cuoio moro brown leather			
	43	0,200	120	60	45	9RAL50.0030.54	vetro bianco white glass			
						9RAL50.0030.55	vetro nero black glass			
FORTYFIVE_NINETY	TAVOLI RIUNIONI Ø 120 MEETING TABLES Ø 120									
	Tavolo riunioni con piano impiallacciato Meeting table with veneered top									
	40	0,080	Ø 120		72	9RAL90.0001.51	palissandro rosewood			
						9RAL90.0001.52	ebano ebony			
						9RAL90.0001.56	cuoio bianco white leather			
						9RAL90.0001.57	cuoio moro brown leather			
	Tavolo riunioni con piano in cristallo temperato verniciato sp.12 mm Meeting table with tempered lacquered glass top 12 mm th.									

FORTYFIVE_NINETY	DESCRIZIONE TECNICA TECHNICAL DESCRIPTION
	<p>CASSETTIERE Struttura esterna e frontali cassetto realizzata con pannelli in agglomerato ligneo di pioppo, placcati a caldo con impiallacciatura di Ebano in abbinamento con profilo alluminio "brill" o Palissandro in abbinamento con profilo alluminio "bianco", bordi in legno sp.1 mm. Verniciatura naturale effettuata con vernici acriliche antingiallenti. Profilo perimetrale delle basi e cappelli realizzato in alluminio in due finiture, ossidato brillante o verniciato bianco. Il cappello della cassetiera può essere realizzato, oltre all'essenza di Ebano e Palissandro, anche in vetro temperato verniciato bianco extra chiaro o nero, in cuoio bianco o testa di moro con cuciture color corda. Struttura interna realizzata in nobilitato melaminico colore grigio alluminio. Cassetti realizzati in pvc con guida a rientro ammortizzato. Maniglia in alluminio con finitura brillante o bianco. Piedini livellatori o ruote e serratura previste di serie.</p> <p>CONTENTORI-CONTENTORI DI SERVIZIO-CONTENTORE PENSILE Struttura esterna, ante e frontali cassetto realizzati con pannelli in agglomerato ligneo di pioppo, placcati a caldo con impiallacciatura di Ebano in abbinamento con profilo alluminio "brill" o Palissandro in abbinamento con profilo alluminio "bianco", bordi in legno sp.1 mm. Verniciatura naturale effettuata con vernici acriliche antingiallenti. Tutti i profili metallici sono realizzati in alluminio in due finiture, ossidato brillante o verniciato bianco. Il cappello del contenitore di servizio può essere realizzato, oltre all'essenza di Ebano e Palissandro, anche in vetro temperato verniciato bianco extrachiaro o nero, o in cuoio bianco o testa di moro con cuciture color corda. Struttura interna e ripiani, sono prodotti in nobilitato melaminico colore grigio alluminio. Cassetti del contenitore di servizio realizzati in pvc con guida con rientro ammortizzato. Le ante in vetro sono realizzate con profili in alluminio in due finiture, ossidato brillante o verniciato bianco e vetro temperato verniciato bianco o nero. Maniglia in alluminio con finitura brillante o bianco. Serratura prevista di serie per i contenitori di servizio. Sia il contenitore pensile che il contenitore pensile con supporti a terra vanno fissati a muro. Su richiesta è possibile abbinare tutte le finiture sia con profilo alluminio brill che profilo alluminio bianco.</p> <p>PEDESTALS External structure and drawer fronts made of poplar-wood agglomerate panels, hot surfaced with ebony veneer teamed with "brill" aluminium profile or rosewood veneer teamed with "white" aluminium profile, 1 mm thick wooden borders. Coated with anti-yellowing acrylic varnishes. Perimeter profile of base units and tops made of aluminium in two finishes, brilliant oxidised or painted white. The top of the pedestal can also be made with tempered glass painted white extra clear or black, white or brown leather with rope coloured seams. Internal structure made of aluminium grey melamine. Drawers made of PVC with soft-closing runners. Aluminium handle with brilliant or white finish. Levelling feet or castors and lock supplied as standard.</p> <p>STORAGE UNITS-SERVICE UNITS-HANGING STORAGE UNITS External structure, doors and drawer fronts made of poplar-wood agglomerate panels, hot surfaced with ebony veneer teamed with "brill" aluminium profile or rosewood teamed with "white" aluminium profile, 1 mm thick wooden borders. Coated with anti-yellowing acrylic varnishes. All the metal profiles are made of aluminium in two finishes, brilliant oxidised or painted white. As an alternative to the ebony and rosewood veneers, the top of the service units can also be made of tempered glass painted black or white extraclear, or white or brown leather with rope coloured seams. Internal structure and shelves are made of aluminium grey melamine. Service unit drawers made of PVC with soft-closing runners. Glass doors are made with aluminium profiles in two finishes, brilliant oxidised or painted white and tempered glass painted black or white. Aluminium handle with brilliant or white finish. Lock supplied as standard on service storage units. Both the hanging storage unit and the hanging storage unit with floor supports must be secured to the wall. All the finishes can be teamed upon request with either the brill finish aluminium profile or the white aluminium profile.</p>

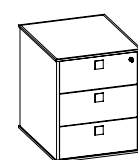
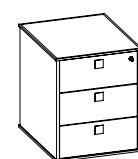
FORTYFIVE_NINETY	CASSETTIERA PEDESTAL									
		P. KG WEIGHT	VOL. M3 VOLUME	LARG. CM WIDTH	PROF. CM DEPTH	ALT. CM HEIGHT	COD. CODE	FINITURE TOP TOP FINISHES	FINITURE STRUTTURA STRUCTURE FINISHES	
									(51) palissandro profilo bianco rosewood/white profile	(52) ebano profilo brill ebony/brillprofile
	<p>Cassetiera su piedi. 3 cassetti con serratura. Pedestal on feet, 3 drawers with lock.</p> 	54,2	0,307	55	65,6	66	9RBN02.0001.51 9RBN02.0001.52 9RBN02.0001.56 9RBN02.0001.57 9RBN02.0001.54 9RBN02.0001.55	palissandro rosewood ebano ebony cuoio bianco white leather cuoio moro brown leather vetro bianco white glass vetro nero black glass		
FORTYFIVE_NINETY	CASSETTIERA PEDESTAL									
		P. KG WEIGHT	VOL. M3 VOLUME	LARG. CM WIDTH	PROF. CM DEPTH	ALT. CM HEIGHT	COD. CODE	FINITURE TOP TOP FINISHES	FINITURE STRUTTURA STRUCTURE FINISHES	
									(51) palissandro profilo bianco rosewood/white profile	(52) ebano profilo brill ebony/brillprofile
	<p>Cassetiera su ruote invisibili. 3 cassetti con serratura. Pedestal on hidden castors, 3 drawers with lock.</p> 	54,2	0,307	55	65,6	66	9RBN01.0001.51 9RBN01.0001.52 9RBN01.0001.56 9RBN01.0001.57 9RBN01.0001.54 9RBN01.0001.55	palissandro rosewood ebano ebony cuoio bianco white leather cuoio moro brown leather vetro bianco white glass vetro nero black glass		

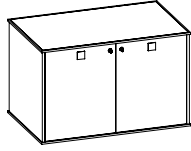
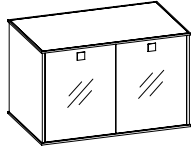
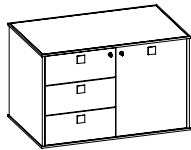
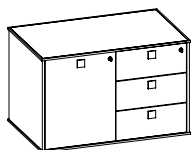
FORTYFIVE_NINETY	CONTENITORI DI SERVIZIO SERVICE UNITS									
	P. KG WEIGHT	VOL. M3 VOLUME	LARG. CM WIDTH	PROF. CM DEPTH	ALT. CM HEIGHT	COD. CODE	FINITURE TOP TOP FINISHES	FINITURE CONTENITORE STORAGE UNIT FINISHES		
								(51) palissandro profilo bianco rosewood/white profile	(52) ebano profilo brill ebony/brillprofile	
Contenitore 2 ante legno. Storage unit 2 wooden doors.	94,3	0,365	104,9	65,6	66	9RBN12.001A.51 9RBN12.001A.52 9RBN12.001A.56 9RBN12.001A.57 9RBN12.001A.54 9RBN12.001A.55	palissandro rosewood ebano ebony cuoio bianco white leather cuoio moro brown leather vetro bianco white glass vetro nero black glass			
Contenitore 2 ante vetro. Service unit 2 glass doors.	95,1	0,365	104,9	65,6	66	9RBN12.001B.51 9RBN12.001B.52 9RBN12.001B.56 9RBN12.001B.57 9RBN12.001B.54 9RBN12.001B.55	palissandro rosewood ebano ebony cuoio bianco white leather cuoio moro brown leather vetro bianco white glass vetro nero black glass			
Contenitore 3 cassetti e 1 anta legno destra. Service unit 3 drawers and 1 right wooden door.	95,2	0,632	104,9	65,6	66	9RBN12.001C.51 9RBN12.001C.52 9RBN12.001C.56 9RBN12.001C.57 9RBN12.001C.54 9RBN12.001C.55	palissandro rosewood ebano ebony cuoio bianco white leather cuoio moro brown leather vetro bianco white glass vetro nero black glass			
Contenitore su piedi 3 cassetti e 1 anta legno sinistra. Service unit 3 drawers and 1 left wooden door.	95,2	0,632	104,9	65,6	66	9RBN12.001D.51 9RBN12.001D.52 9RBN12.001D.56 9RBN12.001D.57 9RBN12.001D.54 9RBN12.001D.55	palissandro rosewood ebano ebony cuoio bianco white leather cuoio moro brown leather vetro bianco white glass vetro nero black glass			

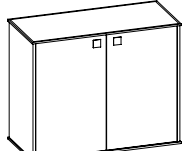
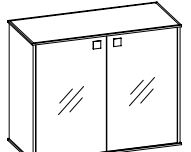
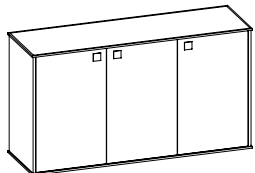
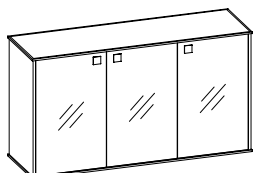
FORTYFIVE_NINETY	CONTENITORI STORAGE UNITS H. 84,5									
	P. KG WEIGHT	VOL. M3 VOLUME	LARG. CM WIDTH	PROF. CM DEPTH	ALT. CM HEIGHT	COD. CODE	FINITURE ANTE DOORS FINISHES		FINITURE CONTENITORE STORAGE UNIT FINISHES	
								(51) palissandro profilo bianco rosewood/white profile	(52) ebano profilo brill ebony/brillprofile	
Contenitore 2 ante legno. Storage unit, 2 wooden doors.	75,4	0,322	104,9	47,6	84,5	9RCN02.001A.51 9RCN02.001A.52	palissandro rosewood ebano ebony			
Contenitore 2 ante vetro. Storage unit, 2 glass doors.	76,2	0,322	104,9	47,6	84,5	9RCN02.002B.54 9RCN02.003B.55	vetro bianco white glass vetro nero black glass			
Contenitore 3 ante legno. Storage unit, 3 wooden doors.	111,9	0,430	154,8	47,6	84,5	9RCN04.001A.51 9RCN04.001A.52	palissandro rosewood ebano ebony			
Contenitore 3 ante vetro. Storage unit, 3 glass doors.	113,0	0,430	154,8	47,6	84,5	9RCN04.002B.54 9RCN04.003B.55	vetro bianco white glass vetro nero black glass			

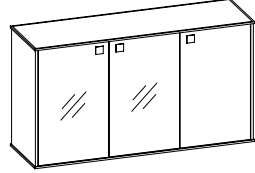
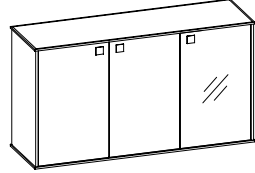
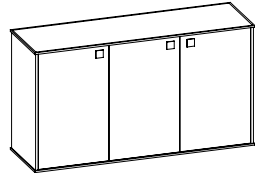
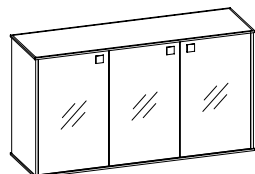
FORTYFIVE_NINETY	CONTENITORI STORAGE UNITS H. 84,5									
	P. KG WEIGHT	VOL. M3 VOLUME	LARG. CM WIDTH	PROF. CM DEPTH	ALT. CM HEIGHT	COD. CODE	FINITURE ANTE DOORS FINISHES	FINITURE CONTENITORE STORAGE UNIT FINISHES		
								(51) palissandro profilo bianco rosewood/white profile	(52) ebano profilo brill ebony/brillprofile	
Contenitore 2 ante vetro ed 1 anta legno destra. Storage unit, 2 glass doors and 1 right wooden door.	112,6	0,430	154,8	47,6	84,5	9RCN04.002C.54 9RCN04.003C.55	vetro bianco white glass vetro nero black glass			
										
Contenitore 2 ante legno ed 1 anta vetro destra. Storage unit, 2 wooden doors and 1 right glass door.	112,2	0,430	154,8	47,6	84,5	9RCN04.002D.54 9RCN04.003D.55	vetro bianco white glass vetro nero black glass			
										
Contenitore 3 ante legno. Storage unit, 3 wooden doors.	111,9	0,430	154,8	47,6	84,5	9RCN04.011A.51 9RCN04.011A.52	palissandro rosewood ebano ebony			
										
Contenitore 3 ante vetro. Storage unit, 3 glass doors.	113,0	0,430	154,8	47,6	84,5	9RCN04.012B.54 9RCN04.013B.55	vetro bianco white glass vetro nero black glass			
										

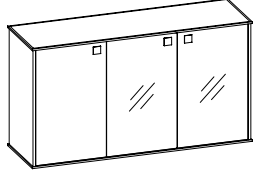
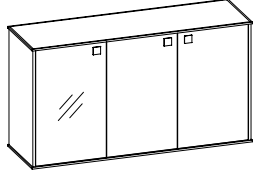
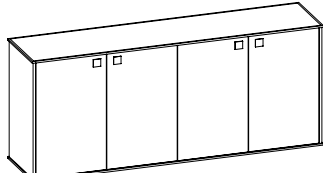
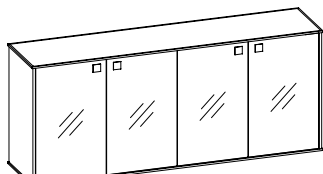
FORTYFIVE_NINETY	CONTENITORI STORAGE UNITS H. 84,5									
	P. KG WEIGHT	VOL. M3 VOLUME	LARG. CM WIDTH	PROF. CM DEPTH	ALT. CM HEIGHT	COD. CODE	FINITURE ANTE DOORS FINISHES	FINITURE CONTENITORE STORAGE UNIT FINISHES		
								(51) palissandro profilo bianco rosewood/white profile	(52) ebano profilo brill ebony/brillprofile	
Contenitore 2 ante vetro ed 1 anta legno sinistra. Storage unit, 2 glass doors and 1 left wooden door.	112,6	0,430	154,8	47,6	84,5	9RCN04.012C.54 9RCN04.013C.55	vetro bianco white glass vetro nero black glass			
										
Contenitore 2 ante legno ed 1 anta vetro sinistra. Storage unit, 2 wooden doors and 1 left glass door.	112,2	0,430	154,8	47,6	84,5	9RCN04.012D.54 9RCN04.013D.55	vetro bianco white glass vetro nero black glass			
										
Contenitore 4 ante legno. Storage unit, 4 wooden doors.	139,7	0,497	204,7	47,6	84,5	9RCN06.001A.51 9RCN06.001A.52	palissandro rosewood ebano ebony			
										
Contenitore 4 ante vetro. Storage unit, 4 glass doors.	141,1	0,497	204,7	47,6	84,5	9RCN06.002B.54 9RCN06.003B.55	vetro bianco white glass vetro nero black glass			
										

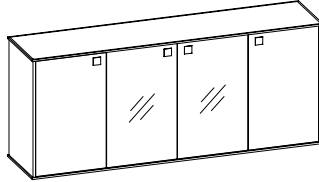
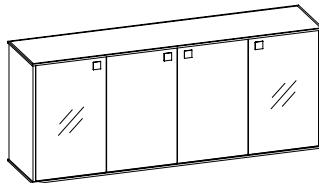
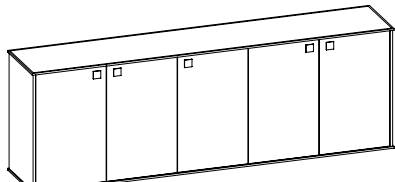
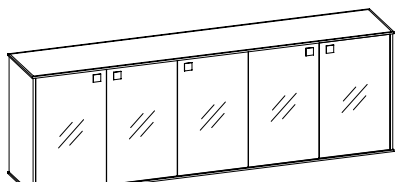
FORTYFIVE_NINETY	CONTENITORI STORAGE UNITS H. 84,5									
	P. KG WEIGHT	VOL. M3 VOLUME	LARG. CM WIDTH	PROF. CM DEPTH	ALT. CM HEIGHT	COD. CODE	FINITURE ANTE DOORS FINISHES	FINITURE CONTENITORE STORAGE UNIT FINISHES		
								(51) palissandro profilo bianco rosewood/white profile	(52) ebano profilo brill ebony/brillprofile	
Contenitore 2 ante legno e 2 ante vetro. Storage unit, 2 wooden doors and 2 glass doors.	149,0	0,537	204,7	47,6	84,5	9RCN07.002A.54 9RCN07.003A.55	vetro bianco white glass vetro nero black glass			
										
Contenitore 2 ante vetro e 2 ante legno. Storage unit, 2 glass doors and 2 wooden doors.	149,0	0,537	204,7	47,6	84,5	9RCN07.002B.54 9RCN07.003B.55	vetro bianco white glass vetro nero black glass			
										
Contenitore 5 ante legno. Storage unit, 5 wooden doors.	176,1	0,794	254,6	47,6	84,5	9RCN08.001A.51 9RCN08.001A.52	palissandro rosewood ebano ebony			
										
Contenitore 5 ante vetro. Storage unit, 5 glass doors.	177,9	0,794	254,6	47,6	84,5	9RCN08.002B.54 9RCN08.003B.55	vetro bianco white glass vetro nero black glass			
										

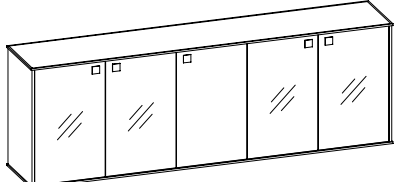
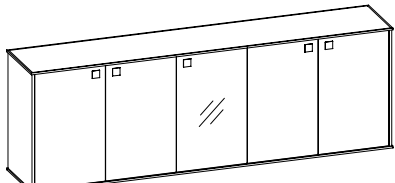
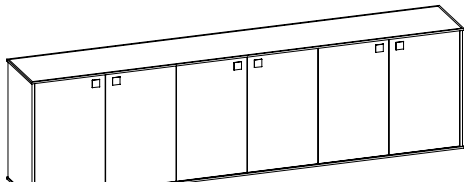
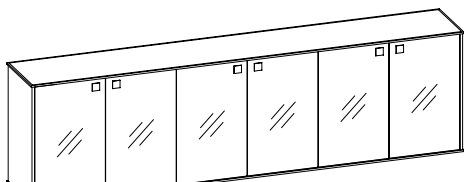

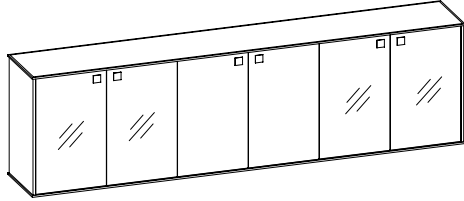
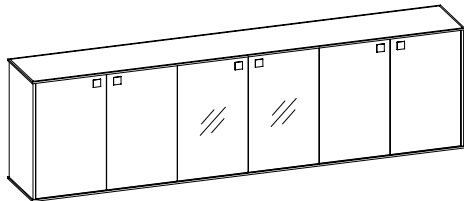
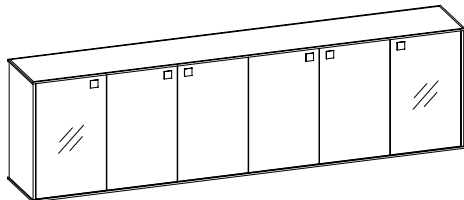
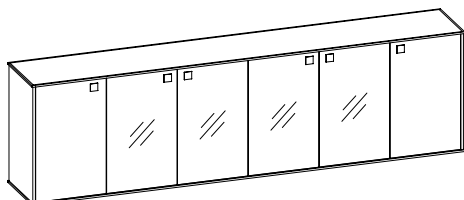
FORTYFIVE_NINETY	CONTENITORI STORAGE UNITS H. 84,5									
	P. KG WEIGHT	VOL. M3 VOLUME	LARG. CM WIDTH	PROF. CM DEPTH	ALT. CM HEIGHT	COD. CODE	FINITURE ANTE DOORS FINISHES	FINITURE CONTENITORE STORAGE UNIT FINISHES		
								(51) palissandro profilo bianco rosewood/white profile	(52) ebano profilo brill ebony/brillprofile	
Contenitore 4 ante vetro e 1 ante legno. Storage unit, 4 glass doors and 1 wooden door.	177,5	0,794	254,6	47,6	84,5	9RCN08.002C.54 9RCN08.003C.55	vetro bianco white glass vetro nero black glass			
										
Contenitore 4 ante legno e 1 ante vetro. Storage unit, 4 wooden doors and 1 glass door.	194,3	0,794	254,6	47,6	84,5	9RCN08.002D.54 9RCN08.003D.55	vetro bianco white glass vetro nero black glass			
										
Contenitore 6 ante legno. Storage unit, 6 wooden doors.	203,9	0,885	304,5	47,6	84,5	9RCN09.001A.51 9RCN09.001A.52	palissandro rosewood ebano ebony			
										
Contenitore 6 ante vetro. Storage unit, 6 glass doors.	206,0	0,885	304,5	47,6	84,5	9RCN09.002B.54 9RCN09.003B.55	vetro bianco white glass vetro nero black glass			
										

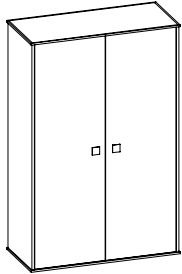
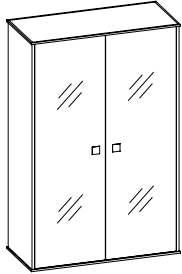
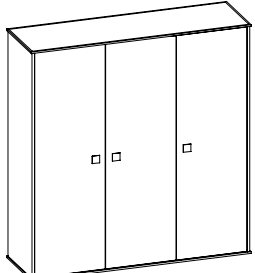
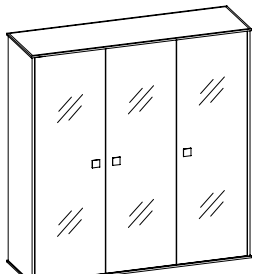

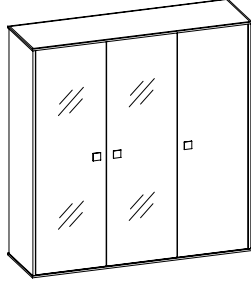
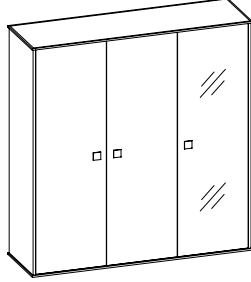
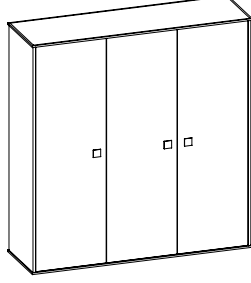
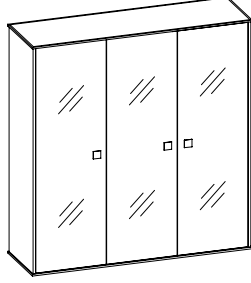
FORTYFIVE_NINETY	CONTENITORI STORAGE UNITS H. 84,5									
	P. KG WEIGHT	VOL. M3 VOLUME	LARG. CM WIDTH	PROF. CM DEPTH	ALT. CM HEIGHT	COD. CODE	FINITURE ANTE DOORS FINISHES	FINITURE CONTENITORE STORAGE UNIT FINISHES		
								(51) palissandro profilo bianco rosewood/white profile	(52) ebano profilo brill ebony/brillprofile	
Contenitore 4 ante vetro e 2 ante legno. Storage unit, 4 glass doors and 2 wooden doors.	212,6	0,898	304,5	47,6	84,5	9RCN09.002C.54 9RCN09.003C.55	vetro bianco white glass vetro nero black glass			
										
Contenitore 4 ante legno e 2 ante vetro. Storage unit, 4 wooden doors and 2 glass doors.	212,6	0,898	304,5	47,6	84,5	9RCN09.002D.54 9RCN09.003D.55	vetro bianco white glass vetro nero black glass			
										
Contenitore 2 ante vetro e 4 ante legno. Storage unit, 2 glass doors and 4 wooden doors.	212,6	0,898	304,5	47,6	84,5	9RCN10.002A.54 9RCN10.003A.55	vetro bianco white glass vetro nero black glass			
										
Contenitore 2 ante legno e 4 ante vetro. Storage unit, 2 wooden doors and 4 glass doors.	212,6	0,898	304,5	47,6	84,5	9RCN10.002B.54 9RCN10.003B.55	vetro bianco white glass vetro nero black glass			
										

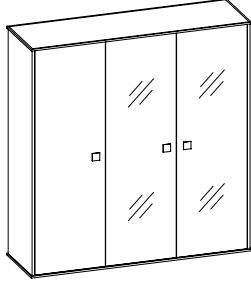
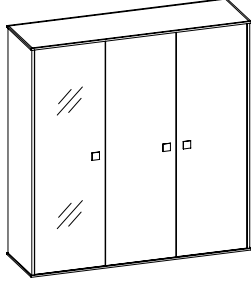
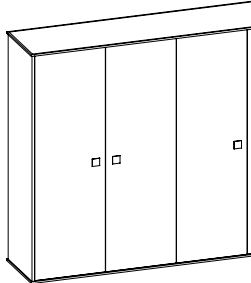
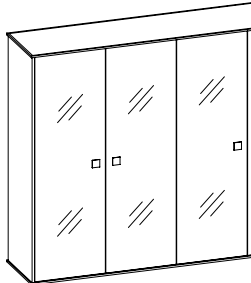

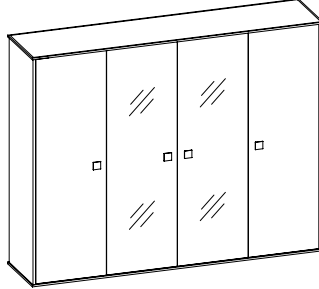
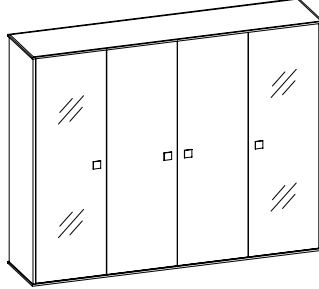
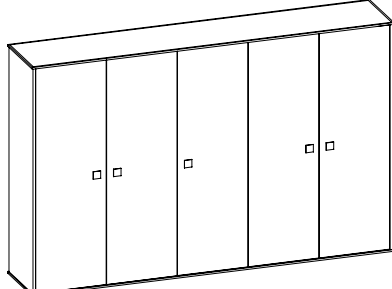
FORTYFIVE_NINETY	CONTENITORI STORAGE UNITS H. 161,2									
	P. KG WEIGHT	VOL. M3 VOLUME	LARG. CM WIDTH	PROF. CM DEPTH	ALT. CM HEIGHT	COD. CODE	FINITURE ANTE DOORS FINISHES	FINITURE CONTENITORE STORAGE UNIT FINISHES		
								(51) palissandro profilo bianco rosewood/white profile	(52) ebano profilo brill ebony/brillprofile	
Contenitore 2 ante legno. Storage unit, 2 wooden doors.	130,7	0,602	104,9	47,6	161,2	9RDN02.001A.51 9RDN02.001A.52	palissandro rosewood ebano ebony			
										
Contenitore 2 ante vetro. Storage unit, 2 glass doors.	129,9	0,602	104,9	47,6	161,2	9RDN02.002B.54 9RDN02.003B.55	vetro bianco white glass vetro nero black glass			
										
Contenitore 3 ante legno. Storage unit, 3 wooden doors.	194,0	0,801	154,8	47,6	161,2	9RDN04.001A.51 9RDN04.001A.52	palissandro rosewood ebano ebony			
										
Contenitore 3 ante vetro. Storage unit, 3 glass doors.	192,7	0,801	154,8	47,6	161,2	9RDN04.002B.54 9RDN04.003B.55	vetro bianco white glass vetro nero black glass			
										

FORTYFIVE_NINETY	CONTENITORI STORAGE UNITS H. 161,2									
	P. KG WEIGHT	VOL. M3 VOLUME	LARG. CM WIDTH	PROF. CM DEPTH	ALT. CM HEIGHT	COD. CODE	FINITURE ANTE DOORS FINISHES	FINITURE CONTENITORE STORAGE UNIT FINISHES		
								(51) palissandro profilo bianco rosewood/white profile	(52) ebano profilo brill ebony/brillprofile	
Contenitore 2 ante vetro e 1 anta legno destra. Storage unit, 2 glass doors and 1 right wooden door. 	193,2	0,801	154,8	47,6	161,2	9RDN04.002C.54 9RDN04.003C.55	vetro bianco white glass vetro nero black glass			
Contenitore 2 ante legno e 1 anta vetro destra. Storage unit, 2 wooden doors and 1 right glass door. 	193,6	0,801	154,8	47,6	161,2	9RDN04.002D.54 9RDN04.003D.55	vetro bianco white glass vetro nero black glass			
Contenitore 3 ante legno. Storage unit, 3 wooden doors. 	194,0	0,801	154,8	47,6	161,2	9RDN04.011A.51 9RDN04.011A.52	palissandro rosewood ebano ebony			
Contenitore 3 ante vetro. Storage unit, 3 glass doors. 	192,7	0,801	154,8	47,6	161,2	9RDN04.012B.54 9RDN04.013B.55	vetro bianco white glass vetro nero black glass			

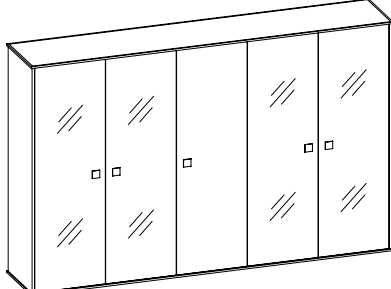
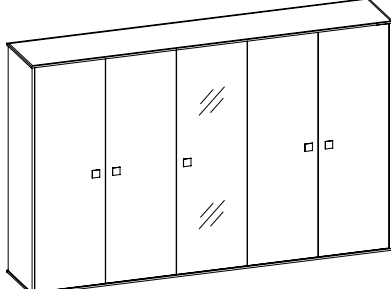
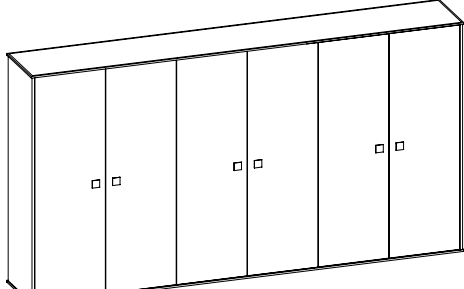

FORTYFIVE_NINETY	CONTENITORI STORAGE UNITS H. 161,2									
	P. KG WEIGHT	VOL. M3 VOLUME	LARG. CM WIDTH	PROF. CM DEPTH	ALT. CM HEIGHT	COD. CODE	FINITURE ANTE DOORS FINISHES	FINITURE CONTENITORE STORAGE UNIT FINISHES		
								(51) palissandro profilo bianco rosewood/white profile	(52) ebano profilo brill ebony/brillprofile	
Contenitore 1 anta legno e 2 ante vetro. Storage unit, 1 wooden door and 2 glass doors. 	193,2	0,801	154,8	47,6	161,2	9RDN04.012C.51 9RDN04.013C.51	vetro bianco white glass vetro nero black glass			
Contenitore 1 vetro legno e 2 ante legno. Storage unit, 1 glass door and 2 wooden doors. 	193,6	0,801	154,8	47,6	161,2	9RDN04.012D.54 9RDN04.013D.55	vetro bianco white glass vetro nero black glass			
Contenitore 4 ante legno. Storage unit, 4 wooden doors. 	240,2	0,921	204,7	47,6	161,2	9RDN06.001A.51 9RDN06.001A.52	palissandro rosewood ebano ebony			
Contenitore 4 ante vetro. Storage unit, 4 glass doors. 	238,5	0,921	204,7	47,6	161,2	9RDN06.002B.54 9RDN06.003B.55	vetro bianco white glass vetro nero black glass			

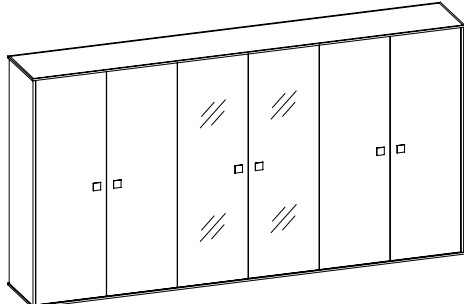
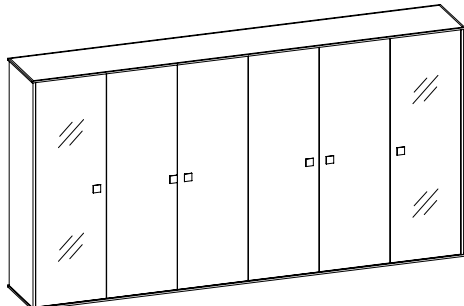
FORTYFIVE_NINETY	CONTENITORI STORAGE UNITS H. 161,2									
	P. KG WEIGHT	VOL. M3 VOLUME	LARG. CM WIDTH	PROF. CM DEPTH	ALT. CM HEIGHT	COD. CODE	FINITURE ANTE DOORS FINISHES	FINITURE CONTENITORE STORAGE UNIT FINISHES		
								(51) palissandro profilo bianco rosewood/white profile	(52) ebano profilo brill ebony/brillprofile	
Contenitore 2 ante legno e 2 ante vetro. Storage unit, 2 wooden doors and 2 glass doors.	256,4	1,000	204,7	47,6	161,2	9RDN07.002A.54 9RDN07.003A.55	vetro bianco white glass vetro nero black glass			
										
Contenitore 2 ante vetro e 2 ante legno. Storage unit, 2 glass doors and 2 wooden doors.	256,4	1,000	204,7	47,6	161,2	9RDN07.002B.54 9RDN07.003B.55	vetro bianco white glass vetro nero black glass			
										
Contenitore 5 ante legno. Storage unit, 5 wooden doors.	316,3	1,250	254,6	47,6	161,2	9RDN08.001A.51 9RDN08.001A.52	palissandro rosewood ebano ebony			
										
Contenitore 5 ante vetro. Storage unit, 5 glass doors.	314,2	1,250	254,6	47,6	161,2	9RDN08.002B.51 9RDN08.003B.52	vetro bianco white glass vetro nero black glass			
										

FORTYFIVE_NINETY	CONTENITORI STORAGE UNITS H. 161,2									
	P. KG WEIGHT	VOL. M3 VOLUME	LARG. CM WIDTH	PROF. CM DEPTH	ALT. CM HEIGHT	COD. CODE	FINITURE ANTE DOORS FINISHES	FINITURE CONTENITORE STORAGE UNIT FINISHES		
								(51) palissandro profilo bianco rosewood/white profile	(52) ebano profilo brill ebony/brillprofile	
Contenitore 4 ante vetro e 1 ante legno. Storage unit, 4 glass doors and 1 wooden door.	314,7	1,250	254,6	47,6	161,2	9RDN08.002C.54 9RDN08.003C.55	vetro bianco white glass vetro nero black glass			
										
Contenitore 4 ante legno e 1 ante vetro. Storage unit, 4 wooden doors and 1 glass door.	315,9	1,250	254,6	47,6	161,2	9RDN08.002D.54 9RDN08.003D.55	vetro bianco white glass vetro nero black glass			
										
Contenitore 6 ante legno. Storage unit, 6 wooden doors.	349,6	1,511	304,5	47,6	161,2	9RDN09.001A.51 9RDN09.001A.52	palissandro rosewood ebano ebony			
										
Contenitore 6 ante vetro. Storage unit, 6 glass doors.	347,2	1,511	304,5	47,6	161,2	9RDN09.002B.54 9RDN09.003B.55	vetro bianco white glass vetro nero black glass			
										

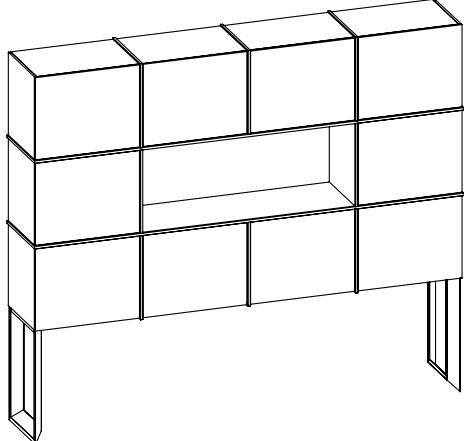
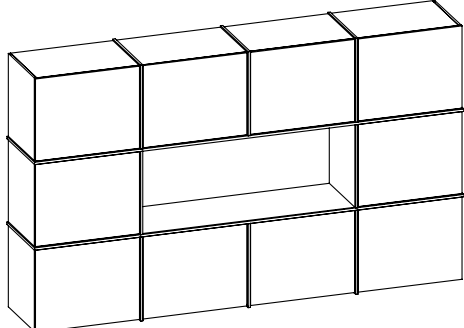
FORTYFIVE_NINETY	CONTENITORI STORAGE UNITS H. 161,2									
	P. KG WEIGHT	VOL. M3 VOLUME	LARG. CM WIDTH	PROF. CM DEPTH	ALT. CM HEIGHT	COD. CODE	FINITURE ANTE DOORS FINISHES	FINITURE CONTENITORE STORAGE UNIT FINISHES		
								(51) palissandro profilo bianco rosewood/white profile	(52) ebano profilo brill ebony/brillprofile	
Contenitore 4 ante vetro e 2 ante legno. Storage unit, 4 glass doors and 2 wooden doors.	348,0	1,511	304,5	47,6	161,2	9RDN09.002C.54 9RDN09.003C.55	vetro bianco white glass vetro nero black glass			
										
Contenitore 4 ante legno e 2 ante vetro. Storage unit, 4 wooden doors and 2 glass doors.	348,8	1,511	304,5	47,6	161,2	9RDN09.002D.54 9RDN09.003D.55	vetro bianco white glass vetro nero black glass			
										
Contenitore 2 ante vetro e 4 ante legno. Storage unit, 2 glass doors and 4 wooden doors.	365,8	1,591	304,5	47,6	161,2	9RDN10.002A.54 9RDN10.003A.55	vetro bianco white glass vetro nero black glass			
										
Contenitore 2 ante legno e 4 ante vetro. Storage unit, 2 wooden doors and 4 glass doors.	365,0	1,591	304,5	47,6	161,2	9RDN10.002B.54 9RDN10.003B.55	vetro bianco white glass vetro nero black glass			
										

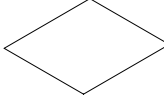
FORTYFIVE_NINETY	CONTENITORE PENSILE CON SUPPORTI IN ALLUMINIO HANGING STORAGE UNITS WITH ALUMINIUM SUPPORTS H. 189,5									
	P. KG WEIGHT	VOL. M3 VOLUME	LARG. CM WIDTH	PROF. CM DEPTH	ALT. CM HEIGHT	COD. CODE	FINITURE ANTE DOORS FINISHES	FINITURE PROFILO E SOSTEGNO PROFILE AND SUPPORT FINISHES		
								(58) brill brill	(59) bianco white	
	109,1	0,556	221,2	39,2	189,5	9REN01.0001A.51 9REN01.0001A.52	palissandro rosewood ebano ebony			
FORTYFIVE_NINETY	CONTENITORE PENSILE HANGING STORAGE UNITS H. 132									
	P. KG WEIGHT	VOL. M3 VOLUME	LARG. CM WIDTH	PROF. CM DEPTH	ALT. CM HEIGHT	COD. CODE	FINITURE ANTE DOORS FINISHES	FINITURE PROFILO E SOSTEGNO PROFILE AND SUPPORT FINISHES		
								(58) brill brill	(59) bianco white	
	103,1	0,532	221,2	39,2	132	9REN02.0001A.51 9REN02.0001A.52	palissandro rosewood ebano ebony			

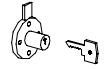
FORTYFIVE_NINETY	MINI COOL.		LARG. CM WIDTH	PROF. CM DEPTH	ALT. CM HEIGHT	T	COD. CODE	FINITURE FINISHES	€
	Con cella ghiaccio with ice cell	39	40	54			90ZEA.C39i.3	lt. 38	
	Per contenitori ad un anta o due ante For storage unit with 1 door or 2 doors								
	Con cella ghiaccio with ice cell	40	39	64			90ZEA.C50i.3	lt. 55	
	Per contenitori a due ante For storage unit with 2 doors								
FORTYFIVE_NINETY	SOTTOMANO WRITING PAD		LARG. CM WIDTH	PROF. CM DEPTH	ALT. CM HEIGHT		COD. CODE	FINITURE FINISHES	€
	Sottomano Writing pad	50	70	3				(66) bianco/white (67) nero/black	
								pelle/leather 9SMP01.0008. __ ecopelle/eco leather 9SME01.0008. __	
	Altri colori sono disponibili su richiesta - Other colours are available on request								
FORTYFIVE_NINETY	VERTEBRA PASSACAVI WIRING VERTEBRA								
							9EC202.8152.80	alluminio/aluminum	
							9EC202.8152.00	trasparente/transparent	
							9EC202.8152.76	cromata/chrome	
FORTYFIVE_NINETY	SERRATURE PER ANTE LEGNO E VETRO LOCKS FOR WOODEN AND GLASS DOORS								
	Serratura per contenitori bassi e per contenitori medi ed alti con ante spezzate. Lock for low size storage units and for medium size and tall storage units with broken doors.						9VS210.0202.03	nichel/nickel	
	Serratura per contenitori medi e alti. Lock for medium size and tall storage units.						9VS330.0172.03	nichel/nickel	

FORTYFIVE_NINETY	ACCESSORI CONTENITORI STORAGE UNITS ACCESSORIES		P. KG WEIGHT	VOL. M3 VOLUME	LARG. CM WIDTH	PROF. CM DEPTH	ALT. CM HEIGHT	COD. CODE	FINITURE FINISHES	€
	Ripiano interno per vano l. 46,4 Internal shelf for compartment 46,4 w.	3,9	0,012	46,4	41	2,5		9RCR01.4801.80	melaminico alluminio melamine aluminium	
										
	Ripiano interno per vano l. 96,3 Internal shelf for compartment 96,3 w.	7,9	0,024	96,3	41	2,5		9RCR02.4801.80	melaminico alluminio melamine aluminium	
										